

## Cooper Bussmann

[Homepage](#)  
[About Cooper Bussmann](#)  
[Contact Us](#)  
[Privacy](#)  
[Legal](#)  
[Cooper Bussmann® Brand](#)  
[Site Map](#)



## ATM-3

Automotive blade-type Mini-Fuse

### Product Information

Product Type:	Fuse
Product Family:	Automotive
Brand:	Cooper Bussmann

### Recommended Products

Rec. Inline Fuse Holder:	<a href="#">HHM</a>
--------------------------	---------------------

### Physical Properties

Dimensions:	0.43in.(L) × 0.15in.(W) × 0.642in.(H)
-------------	---------------------------------------

### Electrical Properties

Maximum DC Voltage:	32
Amperage Rating:	3
DC Interrupting Ratings:	<ul style="list-style-type: none"><li>• 1000 at 32V</li></ul>
Fast Acting:	Yes

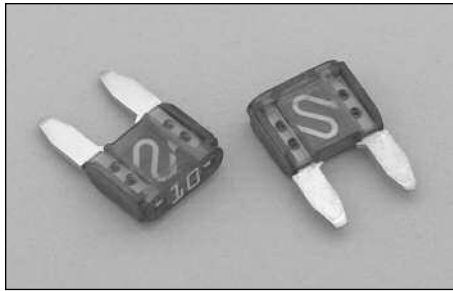

**Dimensional Data**

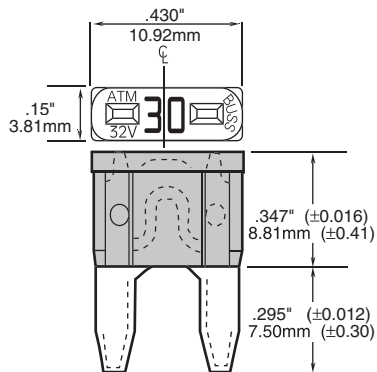

**Catalog Symbol:** ATM

**Fast-Acting**

**Ampere Ratings:** 2 to 30 Amperes

**Interrupting Rating:** 1,000 Amperes

**Ordering:** Specify packaging and product code

**SPECIFICATIONS**

Product Code	Body Color	Voltage Rating DC
ATM-2	Gray	32V
ATM-3	Violet	32V
ATM-4	Pink	32V
ATM-5	Tan	32V
ATM-7 1/2	Brown	32V
ATM-10	Red	32V
ATM-15	Lt. Blue	32V
ATM-20	Yellow	32V
ATM-25	Natural White	32V
ATM-30	Green	32V

**Time-Current Characteristic Curves—Average Melt**

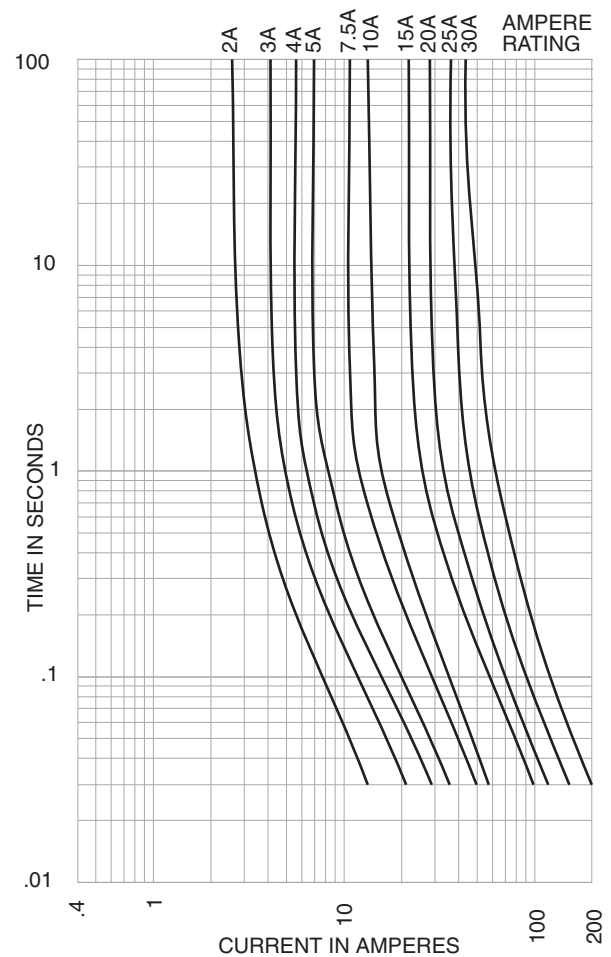

**Recommended Bussmann Fuseholders**

Blade-Type	Part	Description	Fuse Size	Wire Size
ATM	HHM	Fuseholder w/Cover	3-30 Amps	#12 Lead Wire; 4" Length
	HHM-B	Body Only		
	HHM-C	Cover Only	—	—
	HHL	Fuseholder w/Cover	2-20 Amps	#16 Lead Wire; 4" Length
	HHL-B	Body Only		

**PACKAGING CODE**

Packaging Code	Description
Blank	5 pieces of fuses packed in a tin
BK	500 pieces of fuses packed in a carton